

Polymer-tech Solution™

PLASTIC BEARINGS TECHNOLOGY

工程塑料轴承



CSB®



- 成立于1995年，总注册资本7500万人民币；
- 2016年销售额超过4亿元人民币，员工800名；
- 拥有两个生产基地，占地130000m²；
- 国家级高新技术企业，51项专利；
- ISO9001:2008、IATF16949:2016质量认证。
- CSB was established in 1995 and its legal registered capital is 11.5 million US Dollars.
- CSB turnover in 2016 was more than USD 62 million. Currently there are 800 employees working at CSB.
- There are 2 facilities covering over 130000m² with extendable area for future enlargement.
- China National Hi-Tech Enterprise has been granted, 51 patents obtained till now.
- ISO9001: 2008 and IATF16949:2016 quality management system were certificated.

新型自润滑材料适应环境保护要求 Concern for Environment Requirement

CSB积极应对环境保护的要求，通过多年的努力在各个应用领域都已成功开发了满足RoHS要求的不同材料。

Concern for environmental requirement, CSB has developed various kinds of self-lubricating materials to conform to environment requirement.

RoHS指令限制的六种有害物质 EC Directive 2011/65/EU (the RoHS Directive)

汞Hg、六价铬Cr⁶⁺、铅Pb、镉Cd、多溴联苯醚PBDE、多溴联苯PBB。

This directive restricts the use of hazardous substances. Listed below are CSB products which are all RoHS compliant.



"CSB", "Ploymer-tech Solution", "Dry Motion-tech", "Dry-idea", "CSB-EPB", "CSB-LIN", "CSB-FWB", "CSB-LMS", "CSB-BAL", "CSB-RPM", "CSB-PEC", "CSB-PCC", "CSB-PEW", "CSB-PPR", "CSB-FLB", "CSB-CPB", "CSB-PCB", "CSB-PYB", "CSB-SRB" and "CSB-PRB" are legally protected trademarks in China and in case also in foreign countries. 中国保护商标，同时在其它一些国家也受当地法律保护。

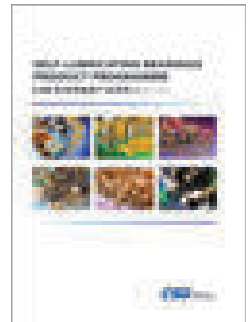
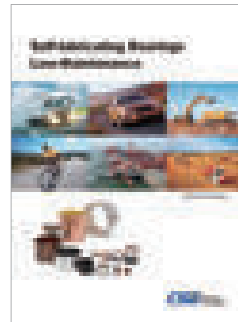
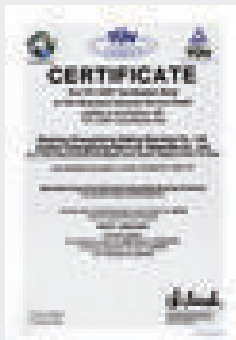
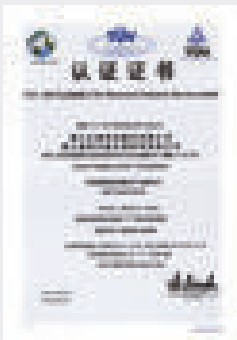
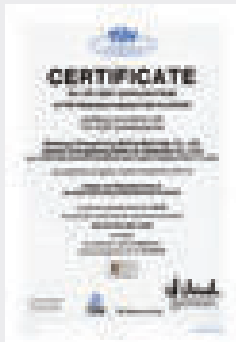
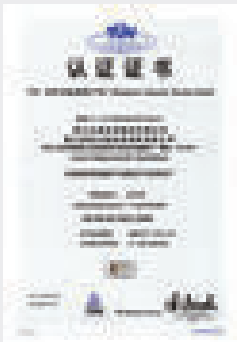

Your Partner for Self-lubricating Bearing Application

为所有工业提供各种自润滑轴承解决方案



CSB-EPB™工程塑料轴承 Plastic Plain Bearings

自润滑免维护、耐腐蚀、长服务寿命、轻量化；可选：极低摩擦系数、高载荷、抗静电、高温250℃、FDA食品安全等级。

Maintenance-free dry operation, Absolute corrosion resistance, Long service time and light; Multiple choices: Lowest friction coefficient, High load, Anti-static, High temperature 250℃, FDA food safety grade.

P12



CSB-BAL™塑料关节轴承 Plastic Spherical Bearings

自润滑免维护、耐腐蚀、抗污垢、轻量化；可选：多种结构设计满足不同安装需求。

Self-lubricating and maintenance-free, Corrosion-resistant, Anti-fouling, lightweight; Multiple structural design to meet different installation requirements.

P188



CSB-LIN™塑料直线轴承 Plastic Linear Bearings

干运行无需供油、抗粉尘、无噪音、耐腐蚀、长服务寿命、轻量化；可选：高温250℃、多种安装方式。

Dry operation without oil, Anti-dust, No noise, Corrosion resistance, Longer service time and light; Multiple Assemble types, Highest operation temperature 250℃.

P186



CSB-LMS™直线驱动系统 Linear Motion Systems

自润滑免维护直线驱动系统，直线滑动原件及丝杆螺母均采用高耐磨EPB13材料制成，实现永久性干摩擦，低噪音、长服务寿命，适合在粉尘或污水下运行。

Self-lubricating and maintenance-free linear motion system, Linear slider and screw nuts are made of high wear-resistant material EPB13, Dry operation for longer time, lower noise, longer service time and suitable for operation in dust or dirty water.

P223



CSB-SFP™耐磨半成品 Semi-finished Products

采用CSB-EPB高耐磨材料制成，可实现非标轴承的快速加工、小批量制作降低成本；可选：棒材、板材、片材。

The semi-finished products are made of anti-wear and high performance materials CSB-EPB, It can be machined non-standard bearings in short time, saving cost for small quantity; Multiple choices: Bar, sheet and tribo-tape.

P281



CSB-PRB™塑料滚动轴承 Plastic Rolling Bearings

自润滑免维护、耐腐蚀、轻量化；可选：内外圈、保持架、滚珠多种材料可选。

Maintenance-free, corrosion-resistant, lightweight; Multiple choices: inner and outer ring, cage and ball can be designed different materials freely.

P291



CSB-SRB™回转支承轴承 Slewing Ring Bearings

免维护干运行、低噪音、轻量化；滑动原件可选耐磨材料EPB13、高载荷金属与特氟龙复合材料CSB-11。

Maintenance-free and dry operation, lower noise, lightweight; The slider can be made of wearresistant material EPB13 or metal and teflon composite material CSB-11 for higher load.

P299



CSB-FWB™纤维缠绕轴承 Filament-wound Bearings

连续长纤维复合材料、干摩擦性能最优越、极高的承载能力、最高静载荷240MPa，特别适合用于高载低速下的摆动。

Long fiber composite material, The best performance for dry operation, High load capacity and max. static load 240MPa, Especially suitable for swing with high load and low speed.

P303

<http://www.csb-ep.com>

Products

CSB-EPB™

www.csb-ep.com
sales@csb-ep.com

Tel: 0086 573 84186133/84185527
Fax: 0086 573 84185517

CSB Product Family

CSB产品

Polymer-tech Solution™

Products

www.csb-ep.com
sales@csb-ep.com
Tel: 0086 573 84186133/84185527
Fax: 0086 573 84185517

CSB-EPB™工程塑料轴承 Plastic Plain Bearings

P 12-167



CSB-LIN™塑料直线轴承 Plastic Linear Bearings

P 186-222



CSB-PRB™塑料滚动轴承 Plastic Rolling Bearings

P 291-294



CSB-BAL™塑料关节轴承 Plastic Spherical Bearings

P 168-185

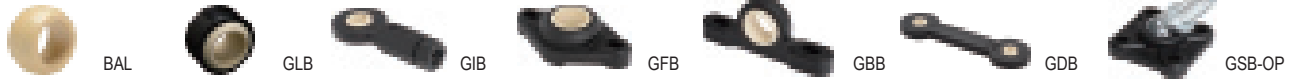

CSB-LMS™直线驱动系统 Linear Motion Systems

P 223-280



CSB-SRB™回转支撑轴承 Slewing Ring Bearings

P 299-302

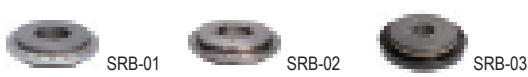

CSB-RPM™转向器支撑套 Steering Rack Bearings

P 295-296



KER转角轴承 Knife edge rollers

P 290



CSB-PEC™扶梯自润滑回转链 Self-lubricated Rotary Chains

P 297-298



CSB-SFP™耐磨半成品 Semi-finished Products

P 281-289



CSB-FWB™纤维缠绕轴承 Filament-wound Bearings

P 303-315



金属自润滑轴承 Metal Sliding Bearings

P 316-317





产品特性 Product Features

- 应用于PCB塑料卡箍轴承无法被定位的场合。对配合孔的精度要求较低。螺栓固定无滑落风险
- 免维护，自润滑
- 螺丝固定安全可靠
- 适用于旋转、摇摆、直线运动
- 对安装孔精度无要求
- Suitable for the application where the CSB plastic clip bearing is hard to be located. The requirement of the fitting hole is not critical and the set screw could be secured without any risk of moving
- Maintenance free, self-lubricated
- Bolt fixture ensures safe and reliability
- Suitable for rotation, oscillation and sliding motions
- Low tolerance requirement for the mounting holes

结构设计 Structure Design

CSB-FLB™法兰轴承内外设计为无需外径压配合既符合轴承配合使用尺寸，故对配合座孔精度无特殊要求；采用螺丝固定轴承，使得轴承在座孔无法确保加工精度时更安全可靠地长久运行。

CSB-FLB™ flange bearing is designed without housing fixture, no tolerance requirement for housing. With the bolt fixture structure, the bearings are reliably operated when housing is not possible to be designed.

材料设计 Material Design

CSB-FLB™ 法兰轴承采用坚固耐用的CSB-EPB3作为标准材料，轴承具较好的自润滑性能和长期的耐磨性能；可以完全干运行；同时CSB可提供低摩擦系数材料CSB-EPB13、耐高温达250℃的材料CSB-EPB5以及符合FDA食品安全等级材料CSB-EPB5A制成法兰轴承。

CSB-FLB™ is made from CSB-EPB3 material which is a solid material with good self-lubricating performance and anti-wear feature suitable for dry operation conditions. At the same time, CSB also provides flange bearings with different materials such as low friction CSB-EPB13, high temperature material CSB-EPB5 and FDA approved CSB-M70 etc.

安装设计 Assembly Design

法兰轴承设计采用螺丝固定使得轴承在长期运动中更为安全可靠。虽然我们设计对轴承配合座孔精度无要求，但如需要获得最佳的使用性能CSB推荐配合座孔为H7公差。

The bolt fixture designation of the flanged bearing ensures a long term reliable operation of the bearings. Although there is no matching housing tolerance requirement, a better operation condition could be achieved if a recommended housing tolerance of H7 is available.

标准规格 Standard Specifications

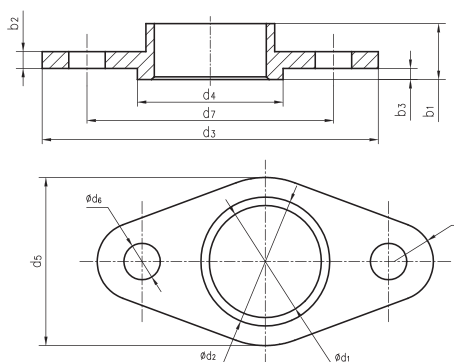

订购编码 Order PN:

FLB3-10

内径 Inner diameter

 材料 Material: EPB3
EPB5
EPB13

座孔 Housing: H7 轴 Shaft: h9

| 订购编码 Order PN | d ₁ [mm] | 公差 Tolerance [mm] | d ₂ [mm] | d ₃ [mm] | d ₄ [mm] | d ₅ [mm] | d ₆ [mm] | d ₇ ± 0.2 [mm] | b ₁ [mm] | b ₂ [mm] | b ₃ [mm] | R [mm] |
|------------------|------------------------|----------------------|------------------------|------------------------|------------------------|------------------------|------------------------|------------------------------|------------------------|------------------------|------------------------|-----------|
| FLB3-10 | 10 | +0.025/+0.083 | 12 | 30 | 14 | 15 | 4.5 | 22 | 6 | 2 | 1 | 4 |
| FLB3-12 | 12 | +0.025/+0.083 | 14 | 36 | 16 | 18 | 4.5 | 26 | 6 | 2 | 1 | 4.5 |
| FLB3-14 | 14 | +0.025/+0.083 | 16 | 42 | 18 | 21 | 5.5 | 30 | 6 | 2 | 1 | 5 |
| FLB3-16 | 16 | +0.025/+0.083 | 18 | 48 | 20 | 24 | 5.5 | 34 | 6 | 2 | 1 | 5.5 |
| FLB3-18 | 18 | +0.025/+0.083 | 20 | 54 | 22 | 27 | 6.5 | 39 | 6 | 2 | 1 | 7 |
| FLB3-20 | 20 | +0.040/+0.124 | 23 | 60 | 26 | 30 | 6.5 | 44 | 10 | 3 | 2 | 7 |
| FLB3-25 | 25 | +0.040/+0.124 | 28 | 75 | 30 | 35 | 6.5 | 55 | 10 | 3 | 2 | 8.5 |
| FLB3-30 | 30 | +0.040/+0.124 | 34 | 90 | 36 | 40 | 8.5 | 66 | 10 | 3 | 2 | 10 |
| FLB13-10 | 10 | +0.025/+0.083 | 12 | 30 | 14 | 15 | 4.5 | 22 | 6 | 2 | 1 | 4 |
| FLB13-12 | 12 | +0.025/+0.083 | 14 | 36 | 16 | 18 | 4.5 | 26 | 6 | 2 | 1 | 4.5 |
| FLB13-14 | 14 | +0.025/+0.083 | 16 | 42 | 18 | 21 | 5.5 | 30 | 6 | 2 | 1 | 5 |
| FLB13-16 | 16 | +0.025/+0.083 | 18 | 48 | 20 | 24 | 5.5 | 34 | 6 | 2 | 1 | 5.5 |
| FLB13-18 | 18 | +0.025/+0.083 | 20 | 54 | 22 | 27 | 6.5 | 39 | 6 | 2 | 1 | 7 |
| FLB13-20 | 20 | +0.040/+0.124 | 23 | 60 | 26 | 30 | 6.5 | 44 | 10 | 3 | 2 | 7 |
| FLB13-25 | 25 | +0.040/+0.124 | 28 | 75 | 30 | 35 | 6.5 | 55 | 10 | 3 | 2 | 8.5 |
| FLB13-30 | 30 | +0.040/+0.124 | 34 | 90 | 36 | 40 | 8.5 | 66 | 10 | 3 | 2 | 10 |

 *d₁公差为压入标准H7座孔 (ISO3547-1) 后公差

 *Tolerance d₁: after being pressed into housing H7(ISO3547-1)

FLB法兰轴承安装方式 Flange Bearings Installation Method

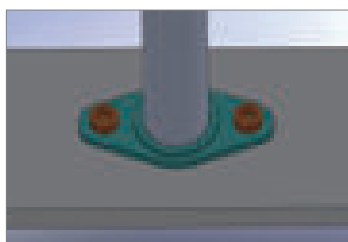
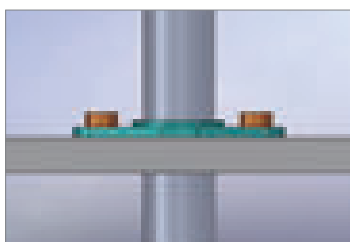

[Http: //www.csb-ep.com](http://www.csb-ep.com)

浙江长盛塑料轴承技术有限公司
地址: 浙江省嘉善惠民街道汾湖路6号
邮编: 314100
Tel: 0573-84186133/84185527
Fax: 0573-84185517
E-mail: sales@csb-ep.com

Zhejiang CSB Plastic Bearing Technology Co.,Ltd.
Add: No.6, Fenhu Road, Huimin Sub-district, Jiashan, Zhejiang, China
Zip Code: 314100
Tel: 0086 573 84185528/84184307
Fax: 0086 573 84183450
E-mail: sales@csb-ep.com

总部: 浙江长盛滑动轴承股份有限公司
地址: 浙江嘉善经济开发区鑫达路6号
[Http: //www.csb.com.cn](http://www.csb.com.cn)

Zhejiang Changsheng Sliding Bearing Co., Ltd.
Add: No.6 Xinda Road, Economic Development Zone,
Jiashan, Zhejiang, China.

CSB全球 CSB Global

□ CSB in Germany

CSB Gleitlager GmbH
Address: Meierstr. 34 - 36, D-32120
Hiddenhausen
Tel: +49(0)5223-985069-0
Fax: +49(0)5223-985069-20
Web-site: www.csb-gleitlager.de
E-mail: info@csb-gleitlager.de

□ CSB in France

CSB Bearing France
Address: 3, Boulevard Eugene Marie
27800 Brionne, France
Tel: +33-232-433276
Fax: +33-970-063257
Web-site: www.csb-bearings.fr
E-mail: p.mouclier@csb-bearings.fr

□ CSB in UK

KRF UK LTD
Address: 6, Biton Road Rugby, CV22
7AB, UK
Tel: +44-1788 5415551
Fax: +44-1788 541368
Web-site: www.krfukltd.co.uk
E-mail: marksmith@krfukltd.co.uk

□ CSB in Sweden

D&E Tradomg AB
Address: Himmelsbodavagen
9, SE-147 39 Tumba, Sweden
Tel: +46 8 4474050
Fax: +46 8 4474060
Web-site: www.detrading.se
E-mail: johan@detrading.se

□ CSB in Finland

D&E Trading OY
Address: Takasenkatu 55
08150 Lohja, Finland
Tel: +358 207 118670
Fax: +358 207 118678
Web-site: www.detrading.fi
E-mail: deoy@detrading.fi

□ CSB in Turkey

O-Pak Ithalat ve Ihracat Ltd. Sti.
Address: Perpa Ticaret Merkezi A-
Blok Kat 5 No: 282-284-286
okmeydanl 34384 istanbul Turkey
Tel: +90-212-222 57 00 / 221 53 15
Fax: +90-212-222 56 99 / 221 23 18
Web-site: www.o-pak.com.tr
E-mail: a.arevyan@o-pak.com.tr

□ CSB in Switzerland

GGT Gleit-Technik AG
Address: Meierskappelstr. 3, CH-
6403 Kuessnacht am Rigi, Switzerland
Tel: +41-418541530
Fax: +41-418541532
Web-site: www.gleitlager.ch
E-mail: info@gleitlager.ch

□ CSB in Canada(Quebec)

Global Bear Inc.
Address: 2064 Chartier Avenue,
Dorval, Quebec, Canada H9P 1H2
Tel: +1-866-631-1110
(Toll free in North America)
+1-514-631-1110
Fax: +1-514-636-7737
Web-site: www.globalbear.ca
E-mail: sales@globalbear.ca

□ CSB in Canada(Ontario)

Global Bear Inc.
Address: 21601 Matheson Blvd.
Unit 10, Mississauga, Ontario,
Canada L4W 1H9
Tel: +1-877-820-4865
(Toll free in North America)
+1-905-624-0612
Fax: +1-905-624-0612
Web: www.globalbear.ca
E-mail: sales@globalbear.ca

□ CSB in India

CSB Sliding Bearing (India) PVT. LTD.
Address: Akash Deep Building Suite
206, Second Floor 26-A,
Barakkhamba Road New Delhi-110001, India
Tel: +91-11-66302220/21
Fax: +91-11-23715557
Web: www.csbslidingbearings.com
E-mail: info@csbslidingbearings.com

