

Polymer-tech Solution™

PLASTIC BEARINGS TECHNOLOGY

工程塑料轴承



CSB®



- 成立于1995年，总注册资本7500万人民币；
- 2016年销售额超过4亿元人民币，员工800名；
- 拥有两个生产基地，占地130000m²；
- 国家级高新技术企业，51项专利；
- ISO9001:2008、IATF16949:2016质量认证。
- CSB was established in 1995 and its legal registered capital is 11.5 million US Dollars.
- CSB turnover in 2016 was more than USD 62 million. Currently there are 800 employees working at CSB.
- There are 2 facilities covering over 130000m² with extendable area for future enlargement.
- China National Hi-Tech Enterprise has been granted, 51 patents obtained till now.
- ISO9001: 2008 and IATF16949:2016 quality management system were certificated.

新型自润滑材料适应环境保护要求 Concern for Environment Requirement

CSB积极应对环境保护的要求，通过多年的努力在各个应用领域都已成功开发了满足RoHS要求的不同材料。

Concern for environmental requirement, CSB has developed various kinds of self-lubricating materials to conform to environment requirement.

RoHS指令限制的六种有害物质 EC Directive 2011/65/EU (the RoHS Directive)

汞Hg、六价铬Cr⁶⁺、铅Pb、镉Cd、多溴联苯醚PBDE、多溴联苯PBB。

This directive restricts the use of hazardous substances. Listed below are CSB products which are all RoHS compliant.



"CSB", "Ploymer-tech Solution", "Dry Motion-tech", "Dry-idea", "CSB-EPB", "CSB-LIN", "CSB-FWB", "CSB-LMS", "CSB-BAL", "CSB-RPM", "CSB-PEC", "CSB-PCC", "CSB-PEW", "CSB-PPR", "CSB-FLB", "CSB-CPB", "CSB-PCB", "CSB-PYB", "CSB-SRB" and "CSB-PRB" are legally protected trademarks in China and in case also in foreign countries. 中国保护商标，同时在其它一些国家也受当地法律保护。

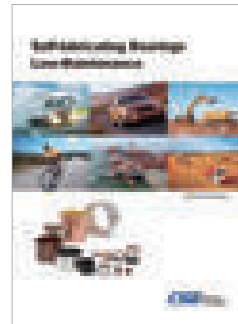
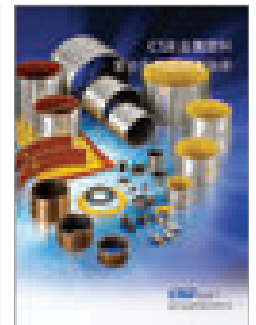
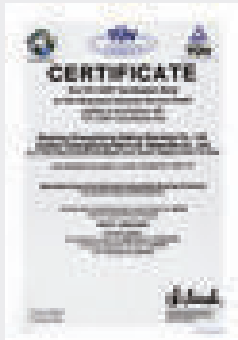
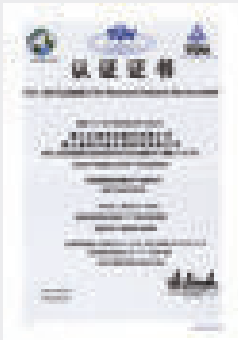
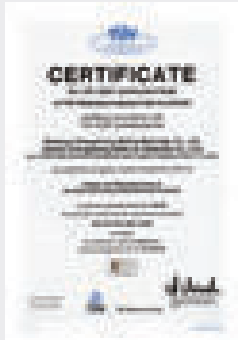
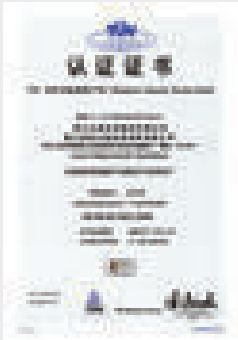

Your Partner for Self-lubricating Bearing Application

为所有工业提供各种自润滑轴承解决方案

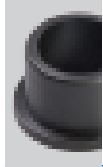

CSB-EPB™工程塑料轴承 Plastic Plain Bearings

自润滑免维护、耐腐蚀、长服务寿命、轻量化；可选：极低摩擦系数、高载荷、抗静电、高温250℃、FDA食品安全等级。

Maintenance-free dry operation, Absolute corrosion resistance, Long service time and light; Multiple choices: Lowest friction coefficient, High load, Anti-static, High temperature 250℃, FDA food safety grade.

P12



CSB-BAL™塑料关节轴承 Plastic Spherical Bearings

自润滑免维护、耐腐蚀、抗污垢、轻量化；可选：多种结构设计满足不同安装需求。

Self-lubricating and maintenance-free, Corrosion-resistant, Anti-fouling, lightweight; Multiple structural design to meet different installation requirements.

P188



CSB-LIN™塑料直线轴承 Plastic Linear Bearings

干运行无需供油、抗粉尘、无噪音、耐腐蚀、长服务寿命、轻量化；可选：高温250℃、多种安装方式。

Dry operation without oil, Anti-dust, No noise, Corrosion resistance, Longer service time and light; Multiple Assemble types, Highest operation temperature 250℃.

P186



CSB-LMS™直线驱动系统 Linear Motion Systems

自润滑免维护直线驱动系统，直线滑动原件及丝杆螺母均采用高耐磨EPB13材料制成，实现永久性干摩擦，低噪音、长服务寿命，适合在粉尘或污水下运行。

Self-lubricating and maintenance-free linear motion system, Linear slider and screw nuts are made of high wear-resistant material EPB13, Dry operation for longer time, lower noise, longer service time and suitable for operation in dust or dirty water.

P223



CSB-SFP™耐磨半成品 Semi-finished Products

采用CSB-EPB高耐磨材料制成，可实现非标轴承的快速加工、小批量制作降低成本；可选：棒材、板材、片材。

The semi-finished products are made of anti-wear and high performance materials CSB-EPB, It can be machined non-standard bearings in short time, saving cost for small quantity; Multiple choices: Bar, sheet and tribo-tape.

P281



CSB-PRB™塑料滚动轴承 Plastic Rolling Bearings

自润滑免维护、耐腐蚀、轻量化；可选：内外圈、保持架、滚珠多种材料可选。

Maintenance-free, corrosion-resistant, lightweight; Multiple choices: inner and outer ring, cage and ball can be designed different materials freely.

P291



CSB-SRB™回转支承轴承 Slewing Ring Bearings

免维护干运行、低噪音、轻量化；滑动原件可选耐磨材料EPB13、高载荷金属与特氟龙复合材料CSB-11。

Maintenance-free and dry operation, lower noise, lightweight; The slider can be made of wearresistant material EPB13 or metal and teflon composite material CSB-11 for higher load.

P299



CSB-FWB™纤维缠绕轴承 Filament-wound Bearings

连续长纤维复合材料、干摩擦性能最优越、极高的承载能力、最高静载荷240MPa，特别适合用于高载低速下的摆动。

Long fiber composite material, The best performance for dry operation, High load capacity and max. static load 240MPa, Especially suitable for swing with high load and low speed.

P303

<http://www.csb-ep.com>

Products

CSB-EPB™

www.csb-ep.com
sales@csb-ep.com

Tel: 0086 573 84186133/84185527
Fax: 0086 573 84185517

CSB Product Family

CSB产品

Polymer-tech Solution™

Products

www.csb-ep.com
sales@csb-ep.com
Tel: 0086 573 84186133/84185527
Fax: 0086 573 84185517

CSB-EPB™ 工程塑料轴承 Plastic Plain Bearings

P 12-167



CSB-LIN™ 塑料直线轴承 Plastic Linear Bearings

P 186-222



CSB-PRB™ 塑料滚动轴承 Plastic Rolling Bearings

P 291-294



CSB-BAL™ 塑料关节轴承 Plastic Spherical Bearings

P 168-185

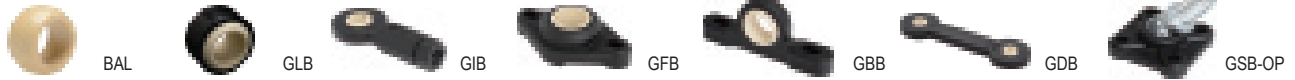

CSB-LMS™ 直线驱动系统 Linear Motion Systems

P 223-280



CSB-SRB™ 回转支撑轴承 Slewing Ring Bearings

P 299-302

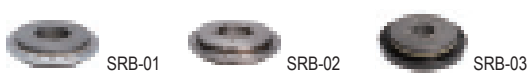

CSB-RPM™ 转向器支撑套 Steering Rack Bearings

P 295-296



KER 转角轴承 Knife edge rollers

P 290



CSB-PEC™ 扶梯自润滑回转链 Self-lubricated Rotary Chains

P 297-298



CSB-SFP™ 耐磨半成品 Semi-finished Products

P 281-289



CSB-FWB™ 纤维缠绕轴承 Filament-wound Bearings

P 303-315



金属自润滑轴承 Metal Sliding Bearings

P 316-317





产品特性 Product Features

- 无间隙轴向预紧设计
- 自动调节装配间隙
- 自润滑免维护
- 消除振动和噪音
- Clearance-free prestressed bearing
- Adjustable fitting gap
- Maintenance-free
- Shock absorbing and noise optimization

结构设计 Structure Design

CSB-CPB™ 无间隙预紧塑料轴承法兰边的特殊设计可以承受轴向的弹性变形，可以自动调节安装产生的轴向间隙；降低机构的振动和运行噪音。

CSB-CPB™ Clearance-free prestressed plastic bearing can adjustable the fitting gap of axial with the flange special design of the elastic feature;The special structure can Shock absorbing and noise optimization.

材料设计 Material Design

CSB-CPB™ 无间隙预紧塑料轴承采用了耐磨专家材料CSB-EPB13，使得塑料轴承在确保弹力的同时具有极好的耐磨性能。当然，CSB也可提供CSB-EPB18材料制成塑料轴承。

CSB-CPB™ Clearance-free prestressed plastic bearing is made from the professional wear resistance material CSB-EPB13 which provides good wear resistance and excellent elastic feature. At the same time, CSB could also provide Plastic bearing with the material CSB-EPB18.

安装设计 Assembly Design

CSB-CPB™ 无间隙预紧塑料轴承能被较小的压力压入到配合座孔中。标准座孔推荐H7公差，标准轴推荐h9公差。

CSB-CPB™ Clearance-free prestressed plastic bearing easy to be pressed into the metal housing by low pressure.The recommended housing tolerance is H7 and axial tolerance is h9.

标准规格 Standard Specifications

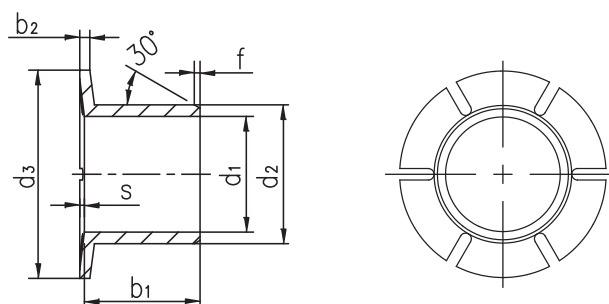

座孔 Housing: H7 轴 Shaft: h9

订购编码 Order PN	d_1 [mm]	d_1 公差 After Fitting [mm]	d_2 [mm]	d_3 [mm]	b_1 [h13] [mm]	b_2 [mm]	s [± 0.1] [mm]	f [mm]
CPB13F-1012-10	10	0.025/0.083	12	18	10	1	0.53	0.5
CPB13F-1214-12	12	0.032/0.102	14	20	12	1	0.53	0.5
CPB13F-1416-12	14	0.032/0.102	16	22	12	1	0.53	0.8

 * d_1 公差为压入标准H7座孔 (ISO3547-1) 后公差

 *Tolerance d_1 : after being pressed into housing H7(ISO3547-1)

订购编码 Order PN:

CPB 13F-1012-10



CPB塑料轴承典型安装方式 Plastic Bearings Installation Method

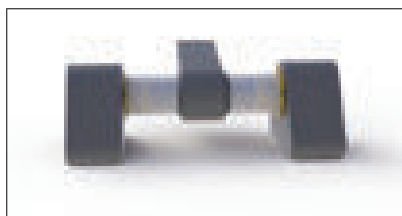

[Http: //www.csb-ep.com](http://www.csb-ep.com)

浙江长盛塑料轴承技术有限公司
地址: 浙江省嘉善惠民街道汾湖路6号
邮编: 314100
Tel: 0573-84186133/84185527
Fax: 0573-84185517
E-mail: sales@csb-ep.com

Zhejiang CSB Plastic Bearing Technology Co.,Ltd.
Add: No.6, Fenhu Road, Huimin Sub-district, Jiashan, Zhejiang, China
Zip Code: 314100
Tel: 0086 573 84185528/84184307
Fax: 0086 573 84183450
E-mail: sales@csb-ep.com

总部: 浙江长盛滑动轴承股份有限公司
地址: 浙江嘉善经济开发区鑫达路6号
[Http: //www.csb.com.cn](http://www.csb.com.cn)

Zhejiang Changsheng Sliding Bearing Co., Ltd.
Add: No.6 Xinda Road, Economic Development Zone,
Jiashan, Zhejiang, China.

CSB全球 CSB Global

▣ CSB in Germany

CSB Gleitlager GmbH
Address: Meierstr. 34 - 36, D-32120
Hiddenhausen
Tel: +49(0)5223-985069-0
Fax: +49(0)5223-985069-20
Web-site: www.csb-gleitlager.de
E-mail: info@csb-gleitlager.de

▣ CSB in France

CSB Bearing France
Address: 3, Boulevard Eugene Marie
27800 Brionne, France
Tel: +33-232-433276
Fax: +33-970-063257
Web-site: www.csb-bearings.fr
E-mail: p.mouclier@csb-bearings.fr

▣ CSB in UK

KRF UK LTD
Address: 6, Biton Road Rugby, CV22
7AB, UK
Tel: +44-1788 5415551
Fax: +44-1788 541368
Web-site: www.krfukltd.co.uk
E-mail: marksmith@krfukltd.co.uk

▣ CSB in Sweden

D&E Tradomg AB
Address: Himmelsbodavagen
9, SE-147 39 Tumba, Sweden
Tel: +46 8 4474050
Fax: +46 8 4474060
Web-site: www.detrading.se
E-mail: johan@detrading.se

▣ CSB in Finland

D&E Trading OY
Address: Takasenkatu 55
08150 Lohja, Finland
Tel: +358 207 118670
Fax: +358 207 118678
Web-site: www.detrading.fi
E-mail: deoy@detrading.fi

▣ CSB in Turkey

O-Pak Ithalat ve Ihracat Ltd. Sti.
Address: Perpa Ticaret Merkezi A-
Blok Kat 5 No: 282-284-286
okmeydanl 34384 istanbul Turkey
Tel: +90-212-222 57 00 / 221 53 15
Fax: +90-212-222 56 99 / 221 23 18
Web-site: www.o-pak.com.tr
E-mail: a.arevyan@o-pak.com.tr

▣ CSB in Switzerland

GGT Gleit-Technik AG
Address: Meierskappelstr. 3, CH-
6403 Kuessnacht am Rigi, Switzerland
Tel: +41-418541530
Fax: +41-418541532
Web-site: www.gleitlager.ch
E-mail: info@gleitlager.ch

▣ CSB in Canada(Quebec)

Global Bear Inc.
Address: 2064 Chartier Avenue,
Dorval, Quebec, Canada H9P 1H2
Tel: +1-866-631-1110
(Toll free in North America)
+1-514-631-1110
Fax: +1-514-636-7737
Web-site: www.globalbear.ca
E-mail: sales@globalbear.ca

▣ CSB in Canada(Ontario)

Global Bear Inc.
Address: 21601 Matheson Blvd.
Unit 10, Mississauga, Ontario,
Canada L4W 1H9
Tel: +1-877-820-4865
(Toll free in North America)
+1-905-624-0612
Fax: +1-905-624-0612
Web: www.globalbear.ca
E-mail: sales@globalbear.ca

▣ CSB in India

CSB Sliding Bearing (India) PVT. LTD.
Address: Akash Deep Building Suite
206, Second Floor 26-A,
Barakkhamba Road New Delhi-110001, India
Tel: +91-11-66302220/21
Fax: +91-11-23715557
Web: www.csbslidingbearings.com
E-mail: info@csbslidingbearings.com

